

LOW VF MOUNT BRIDGE RECTIFIER

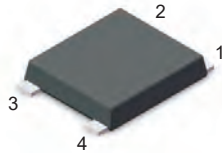

LSB Package

PINNING

PIN	DESCRIPTION
1	Input Pin (~)
2	Input Pin (~)
3	Output Anode (+)
4	Output Cathode (-)

Features

- Glass Passivated Chip Junction
- Reverse Voltage - 600 V
- Forward Current - 4A
- High Surge Current Capability
- Designed For Surface Mount Application

Benefits

- Case: LSB
- Terminals: Solderable Per MIL-STD-750
- Approx. Weight: 0.461g / 0.0163oz

Maximum Ratings and Electrical characteristics

Ratings at 25 °C ambient temperature unless otherwise specified.

Single phase half-wave 60 Hz, resistive or inductive load, for capacitive load current derate by 20 %.

Parameter	Symbols	LSB40JL	Units
Maximum Repetitive Peak Reverse Voltage	VRRM	600	V
Maximum RMS voltage	VRMS	420	V
Maximum DC Blocking Voltage	VDC	600	V
Average Rectified Output Current	I_o	4	A
Peak Forward Surge Current 8.3 ms Single Half Sine Wave Superimposed on Rated Load (JEDEC Method)	IFSM	150	A
$I^2 t$ rating for fusing (1ms < t < 10ms)	$I^2 t$	112.5	A ² S
Maximum Forward Voltage at 2.0 A	VF	0.9	V
Maximum DC Reverse Current @TA=25 °C at Rated DC Blocking Voltage @TA=125 °C	IR	5 100	μA
Typical Junction Capacitance (Note1)	Cj	50	pF
Operating and Storage Temperature Range	Tj, Tstg	-55 ~ +150	°C

Note: 1. Measured at 1MHz and applied reverse voltage of 4 VDC.

2. Mounted on glass epoxy PC board with 4 × 1.5" × 1.5" (3.81 × 3.81 cm) copper pad

RATINGS AND CHARACTERISTICS CURVES (TA = 25 °C unless otherwise noted)

Fig.1 Average Rectified Output Current Derating Curve

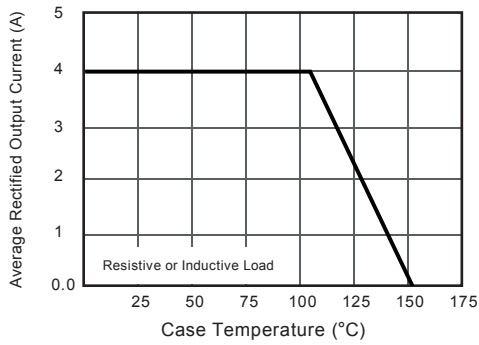

Fig.2 Typical Junction Capacitance

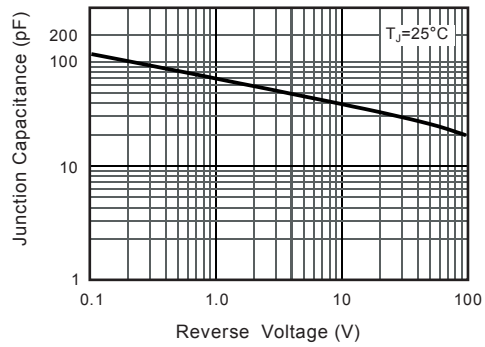

Fig.3 Typical Instantaneous Forward Characteristics

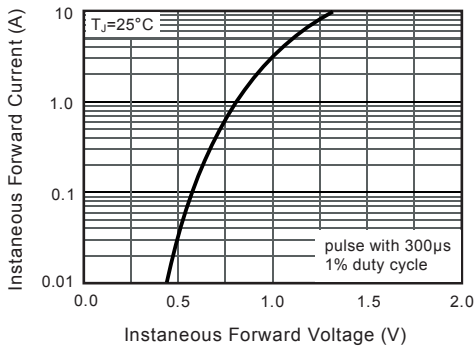

Fig.4 Typical Transient Thermal Impedance

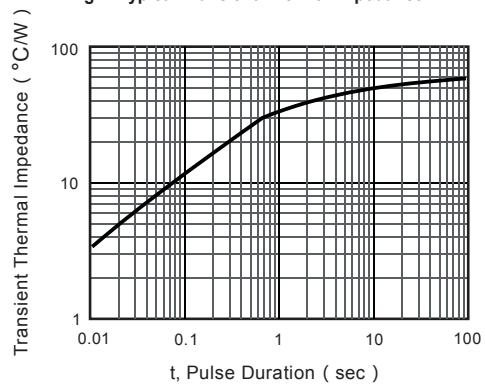
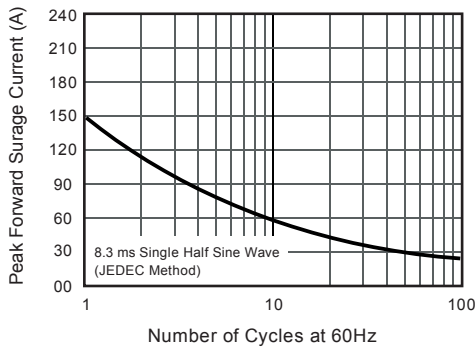
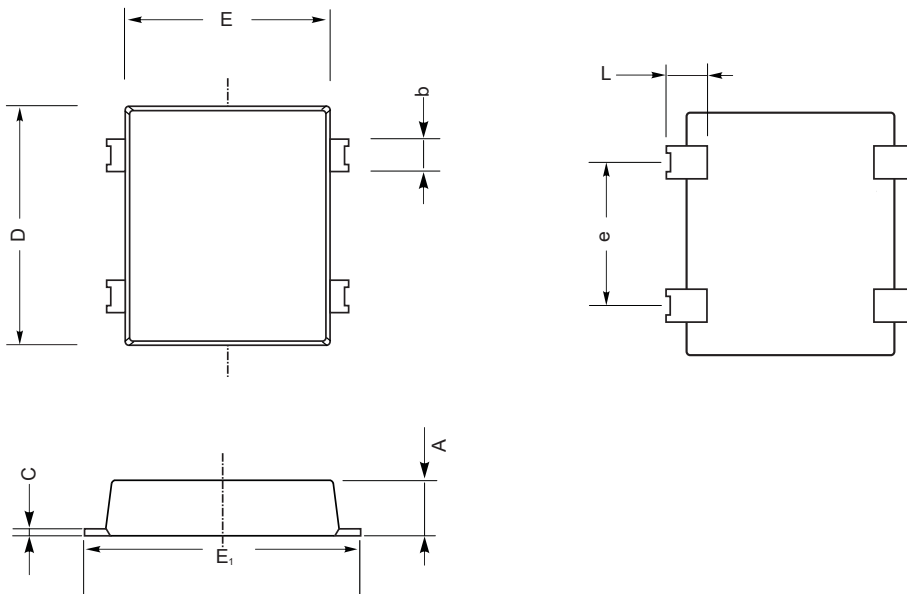

Fig.5 Maximum Non-Repetitive Peak Forward Surge Current



PACKAGE OUTLINE DIMENSIONS

LSB



LSB mechanical data

UNIT		A	C	D	E	E1	L	e	b
mm	max	1.75	0.55	9.8	8.8	10.2	1.25	5.3	1.55
	min	1.35	0.25	9.4	8.4	9.8	0.85	4.9	1.25
mil	max	68	21.6	385	346	401	49	209	61
	min	53	9.8	370	330	385	33	193	49

LSB Suggested Pad Layout

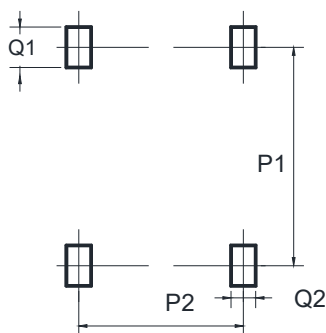

UNIT		P1	P2	Q1	Q2
mm	min	10.0	5.10	1.5	1.8
mil	min	393.7	200.8	59.1	70.9

Dimensions is millimeters

Marking Information

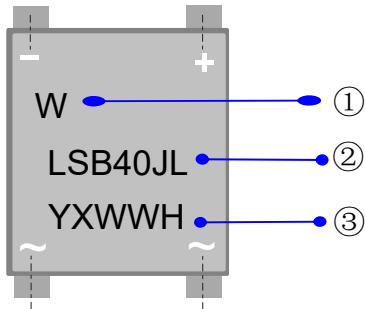

①W : Company's trademark

②Product model : LSB40JL

③PDC information:

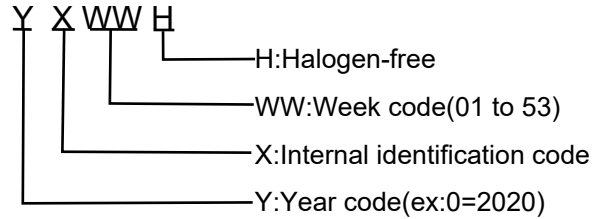

Packaging Information

1.Reel Dimensions

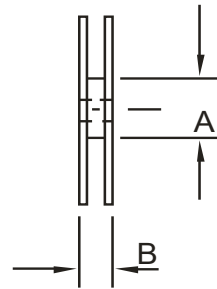
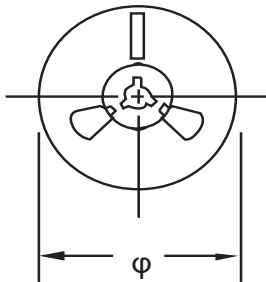

2.Inside Box

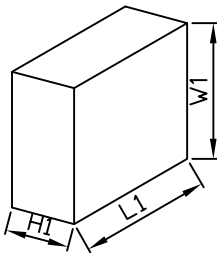

3.Outside Box

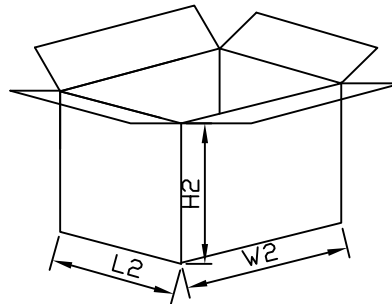

Packaging Information

NO	UNIT	Reel Dimensions			Inside Box			Outside Box		
		φ	A	B	L1	W1	H1	L2	W2	H2
Size	mm	330	100	22	335	335	52	360	360	270
QTY	PCS	Smallest package,3000PCS/reel			6,000PCS,2 reel in total			30,000PCS/carton,5boxes in total		
Note	Tolerance ≤20mm,±3mm; 21-100mm,±5mm; 101-500mm,±10mm									