

## Trench MOS Barrier Schottky Rectifier

**TSP15L100SP**

**TO-277**

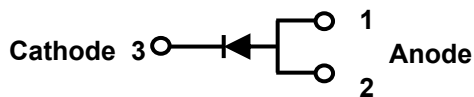

### Features

- Advanced trench technology
- Low forward voltage drop
- Low power losses
- High efficiency operation
- Lead Free Finish, RoHS Compliant

### Applications

- DC/DC Converters
- AC/DC Adaptors
- Switching Power Supplies
- Freewheeling Diodes

### Maximum ratings and electrical characteristics (T<sub>J</sub> = 25°C unless otherwise noted)

Parameter		Symbol	Limit		Unit	
Maximum repetitive peak reverse voltage		VRRM	100		V	
Maximum average forward rectified current		IF(AV)	15		A	
Peak forward surge current 8.3 ms single half sine- wave superimposed on rated load per diode		IFSM	180		A	
Operating junction and storage temperature range		TJ, TSTG	-50 to +150		°C	
Typical thermal resistance per diode(Mounted on FR-4 PCB)		RθJC	72		°C/W	
Instantaneous forward voltage per diode		VF(1)	TYP.	MAX.	V	
	IF=5A		TJ=25°C	0.48		0.53
	IF=5A		TJ=125°C	0.43		-
	IF=15A		TJ=25°C	0.70		0.75
	IF=15A		TJ=125°C	0.65		-
Instantaneous reverse current per diode at rated reverse voltage		IR(2)	TJ=25°C	20	200	uA
			TJ=125°C	-	30	mA

Notes:

(1) Pulse test: 300 μs pulse width, 1 % duty cycle

(2) Pulse test: Pulse width ≦ 40 ms

## RATINGS AND CHARACTERISTICS CURVES (TA = 25 °C unless otherwise noted)

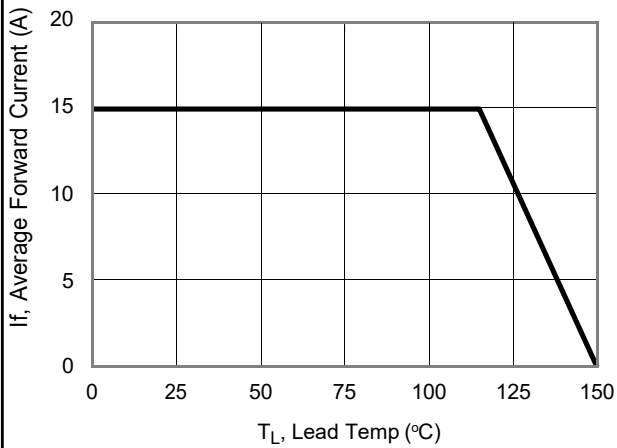

**Current Derating, Case**

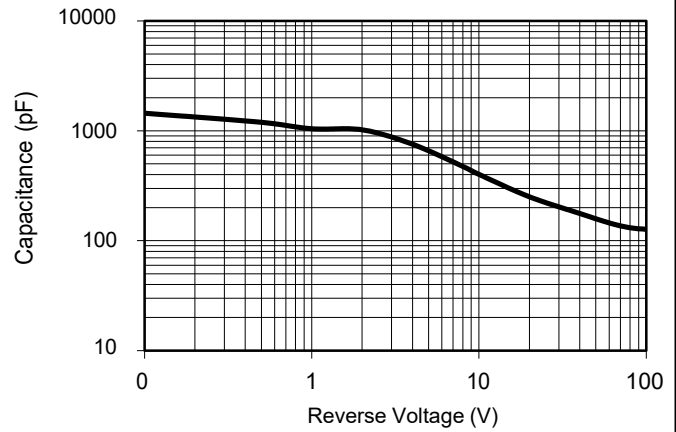

**Typical Junction Capacitance**

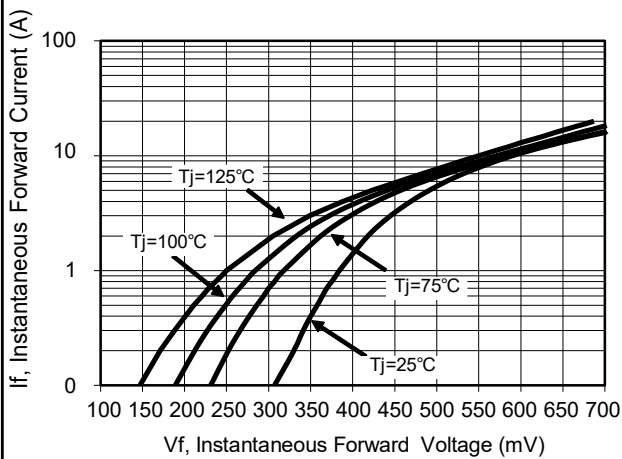

**Typical Forward Voltage**

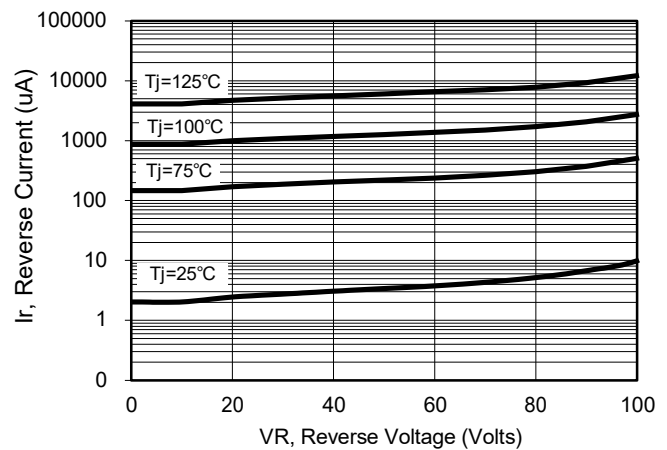

**Typical Reverse Current**

## PACKAGE OUTLINE DIMENSIONS

### TO-277

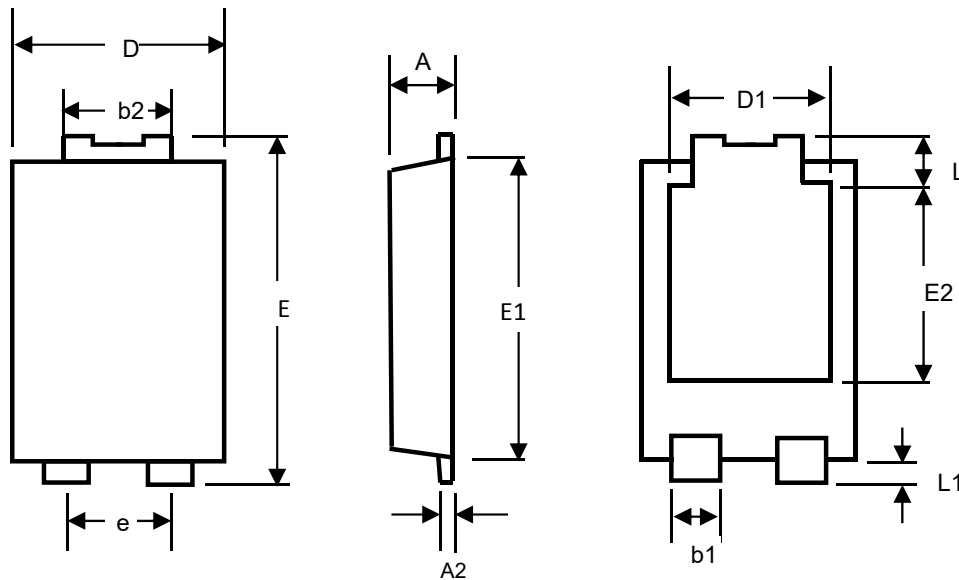

### TO-277 Mechanical Data

UNIT		A	A2	b1	b2	D	D1	E	E1	E2	L	L1
mm	max	1.3	0.4	1.0	1.9	4.3	3.05	6.6	5.75	3.55	1.0	0.7
	min	1.1	0.2	0.8	1.7	3.9		6.4	5.3		0.8	0.5
mil	max	51.18	15.75	39.37	74.80	169.3	120.0	259.8	226.3	139.7	39.37	27.55
	min	43.30	7.87	31.49	66.93	153.5		252.0	208.6		31.49	19.69

### TO-277 Suggested Pad Layout

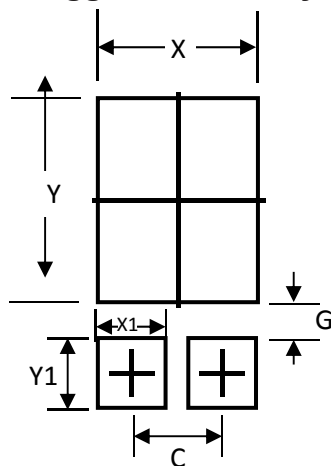

UNIT		C	G	X	X1	Y	Y1
mm	min	1.80	0.90	3.4	1.4	4.9	1.4
mil	min	78.86	35.43	133.86	35.43	192.91	55.12

## Marking Information

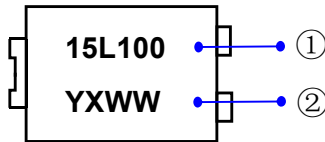

① Product model :TSP15L100SP Referred to as 15L100

② PDC information:

Y X WW

WW:Week code(01 to 53)

X:Internal identification code

Y:Year code(ex:0=2020)

## Packaging Information

### 1.Reel Dimensions

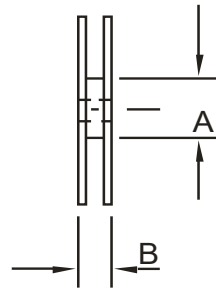
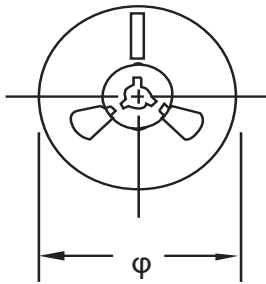

### 2. Inside Box

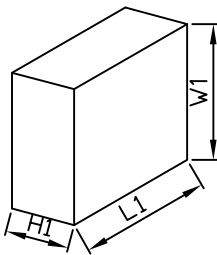

### 3. Outside Box

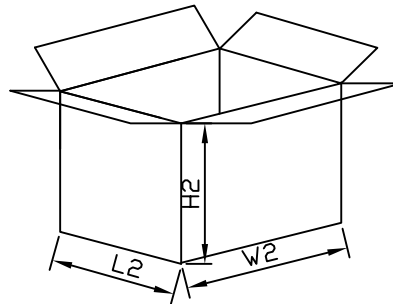

## Packaging Information

NO	UNIT	Reel Dimensions			Inside Box			Outside Box		
		φ	A	B	L1	W1	H1	L2	W2	H2
Size	mm	330	70	15	335	335	43	360	360	360
QTY	PCS	Smallest package,5000PCS/reel			10,000PCS,2 reel in total			80,000PCS/carton,8 boxes in total		
Note	Tolerance ≤20mm,±3mm; 21-100mm,±5mm; 101-500mm,±10mm									