

Trench MOS Barrier Schottky Rectifier

TO-247
TSR40L300PT

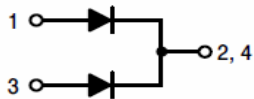
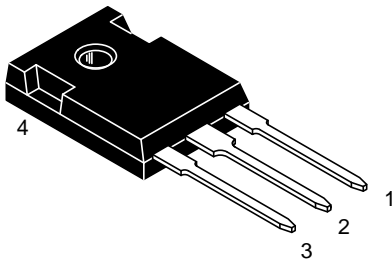

Features

- Advanced trench technology
- Low forward voltage drop
- Low power losses
- High efficiency operation
- Lead Free Finish, RoHS Compliant

Applications

- DC/DC Converters
- AC/DC Adaptors
- Switching Power Supplies
- Freewheeling Diodes

Maximum ratings and electrical characteristics (T_J = 25°C unless otherwise noted)

Parameter		Symbol	Limit		Unit
Maximum repetitive peak reverse voltage		VRRM	300		V
Maximum average forward rectified current	device	IF(AV)	40		A
	per diode		20		
Peak forward surge current 8.3 ms single half sine- wave superimposed on rated load per diode		IFSM	280		A
Operating junction and storage temperature range		TJ, TSTG	-50 to +175		°C
Typical thermal resistance per leg	TO-247	RθJC	2		°C/W
Instantaneous forward voltage per diode			TYP.	MAX.	V
	IF=5A	TJ=25°C	0.73	0.78	
	IF=5A	TJ=125°C	0.66	-	
	IF=20A	TJ=25°C	0.88	0.94	
	IF=20A	TJ=125°C	0.82	-	
Instantaneous reverse current per diode at rated reverse voltage	TJ=25°C		1	10	µA
	TJ=125°C		1	-	mA

Notes:

(1) Pulse test: 300 µs pulse width, 1 % duty cycle

(2) Pulse test: Pulse width ≦ 40 ms

RATINGS AND CHARACTERISTICS CURVES (TA = 25 °C unless otherwise noted)

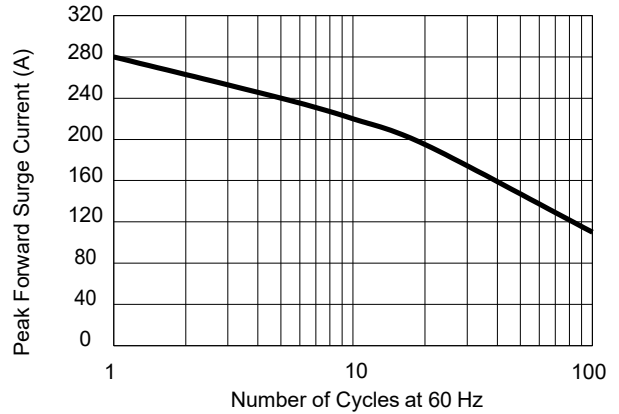
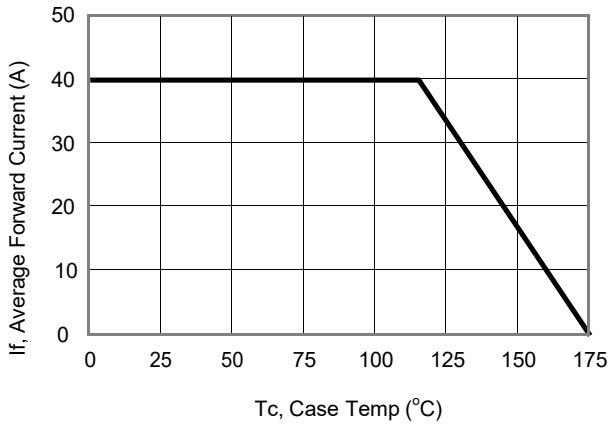

Current Derating, Case

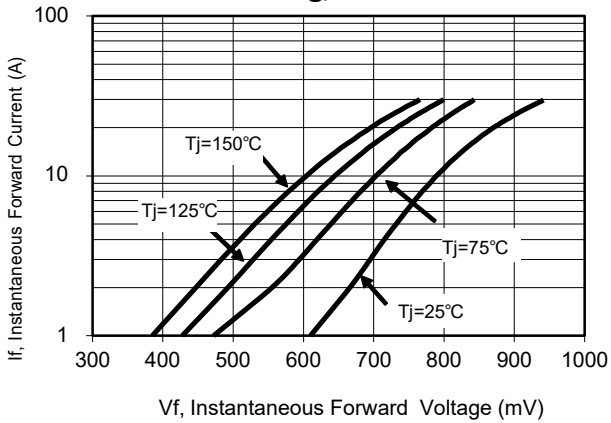
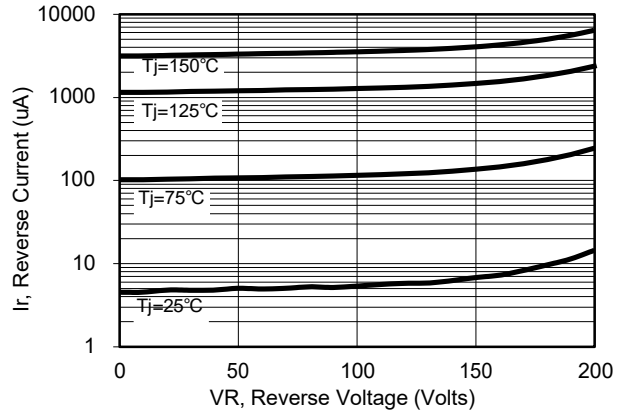
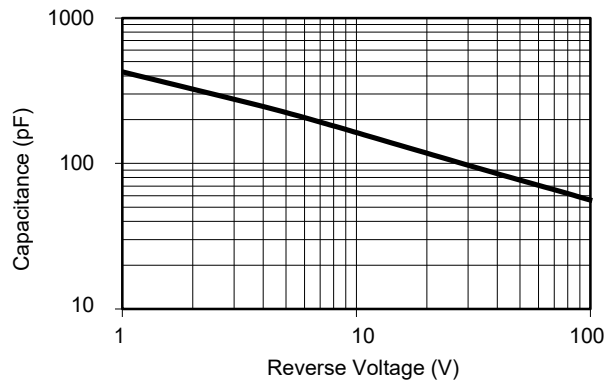

Figure 2: Maximum Repetitive Surge Current



Typical Forward Voltage



Typical Reverse Current

Typical Junction Capacitance

PACKAGE OUTLINE DIMENSIONS

Note:unit: mm

TO-247

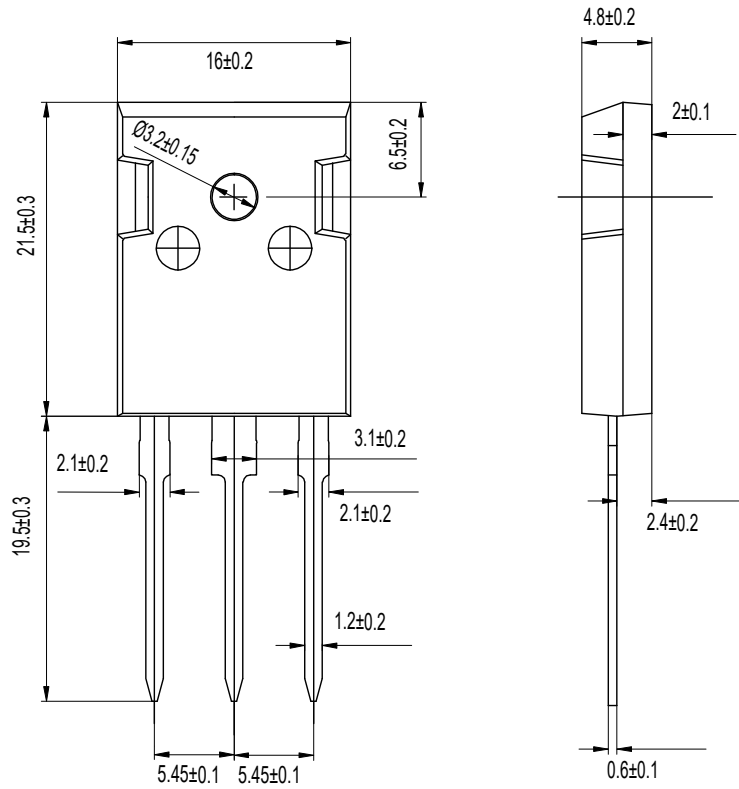

Dimensions in millimeters